

OUTLINE 3-PHASE INDUCTION MOTOR

TOTALLY ENCLOSED FAN
COOLED, SQUIRREL CAGE
ROTOR
*HIGH EFFICIENCY
IE2 SERIES*

FILE NO:
CUSTOMER:
PO. NO:
ORDER NO:

OUTPUT	POLE	SYN. SPEED	VOLT.	FREQ	TIME RATING	MODEL	FRAME NO.
	2				S1	FPFC	80M

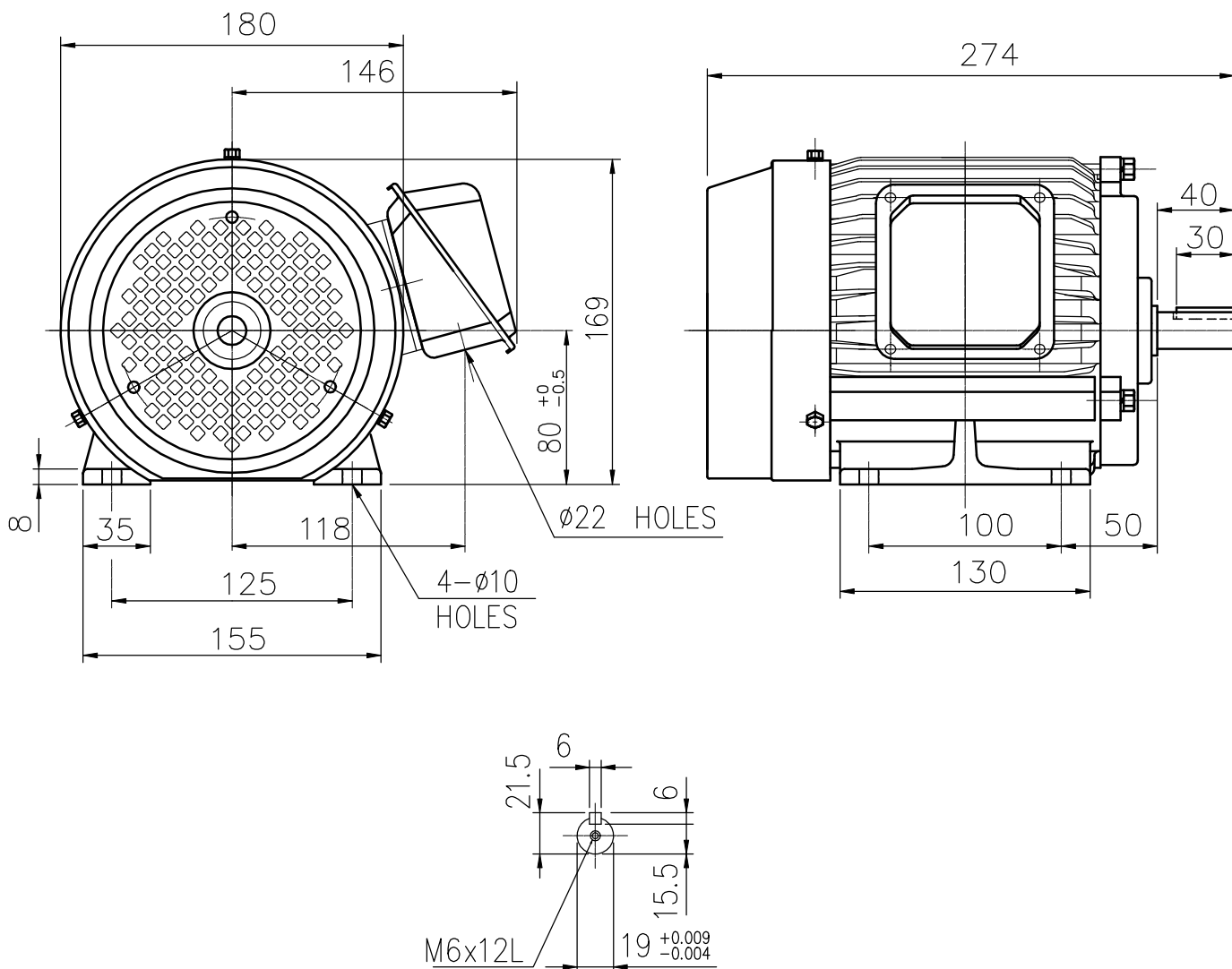

NOTE: 1. F CLASS INSULATION.

BEARING NO.		APPROX WEIGHT
D.E	O.D.E	
6204ZZ	6204ZZ	16kg

初步圖面，僅供參考

CERTIFIED BY: _____		DATE: _____	
DESIGNED	S.S.Jan.	DWG. NO: AS-022656	REV.
CHECKED	Eagle HUNG	3RD ANGLE PROJECTION	(00)
APPROVED	Eagle HUNG	DIMENSION IN mm	

