

OUTLINE 3-PHASE INDUCTION MOTOR

TOTALLY ENCLOSED FAN
COOLED, SQUIRREL CAGE
ROTOR
*HIGH EFFICIENCY
IE2 SERIES*

FILE NO:
CUSTOMER:
PO. NO:
ORDER NO:

OUTPUT	POLE	SYN. SPEED	VOLT.	FREQ	TIME RATING	MODEL	FRAME NO.
					S1	FPFC	280M

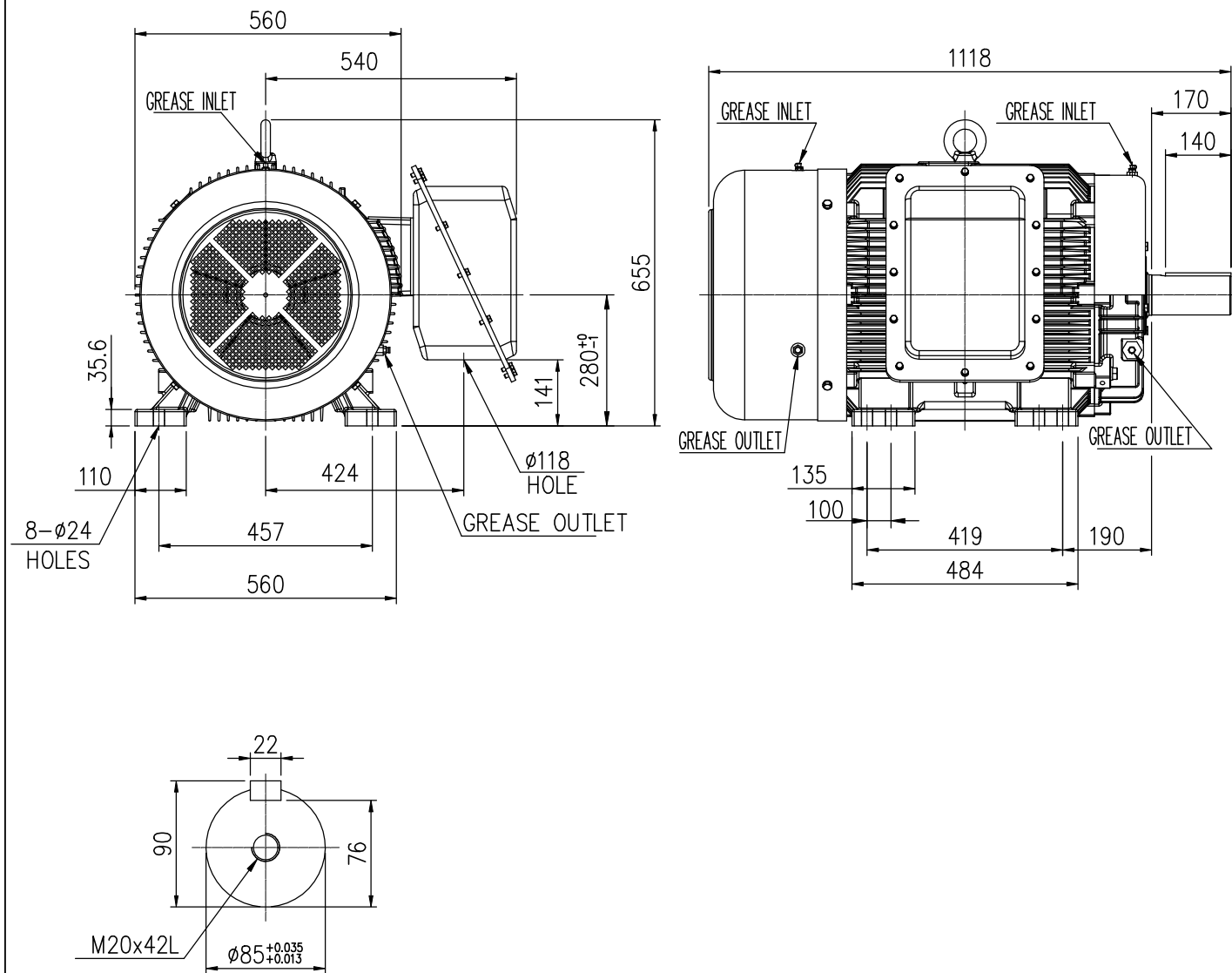

NOTE: 1. F CLASS INSULATION.
2. FOR DIRECT COUPLING.

BEARING NO.		APPROX WEIGHT
D.E	O.D.E	
6318ZC3	6316ZC3	770 kg

Preliminary Drawing for Reference Only

CERTIFIED	BY: _____	DATE: _____
DESIGNED	STONE CHANG	DWG. NO: AS-022684
CHECKED	Eagle HUNG	3RD ANGLE PROJECTION
APPROVED	Eagle HUNG	DIMENSION IN mm



(00)