

# OUTLINE 3-PHASE INDUCTION MOTOR (TS21F II SERIES)

TOTALLY ENCLOSED  
FAN COOLED  
SQUIRREL CAGE ROTOR  
ANTI-FRICTION BEARING

PROJECT NO:

CUSTOMER:

PO. NO:

ORDER NO:

OUTPUT	POLE	SYN. SPEED	VOLT.	FREQ	INSUL.	TIME RATING	MODEL	FRAME NO.
		RPM	V	HZ	F	CONT.	TIK-FCK	N500LL

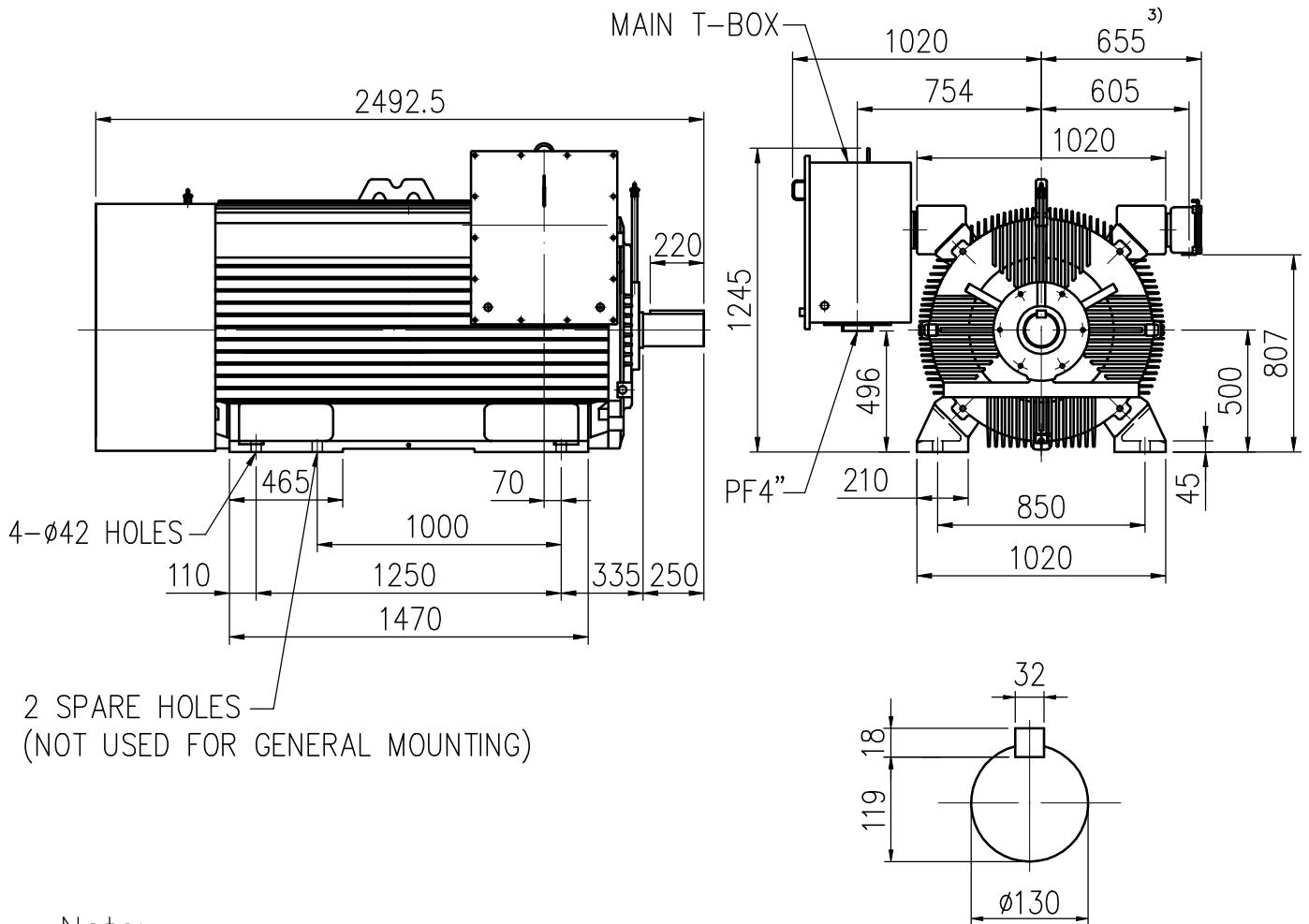

2 SPARE HOLES  
(NOT USED FOR GENERAL MOUNTING)

Note:

- 1) Tolerance of shaft end diameter: m6
- 2) Tolerance of shaft center height: +0 , -1.0
- 3) Auxiliary terminal box is optional and dependent on specified accessories.
- 4) For direct coupling.
- 5) Approximate weight of maximum rated power= 6400 kg
- 6) Drive end bearing: 6230C3  
Opposite drive end bearing: 6324C3
- 7) ROTATION: C.W Viewed from Non-Drive end.

Preliminary only



BASIC DWG NO: FB- 5922

CERTIFIED BY:		DATE:
DESIGNED	C.C.LIAO	DIMENSIONS IN mm
CHECKED	W.C.HAUNG	3RD ANGLE PROJECTION
APPROVED	T.F.CHENG	DATE: