

OUTLINE 3-PHASE INDUCTION MOTOR	TOTALLY ENCLOSED FAN COOLED SQUIRREL CAGE ROTOR ANTI-FRICTION BEARING	PROJECT NO:
		CUSTOMER: PO. NO: ORDER NO:

OUTPUT	POLE	SYN. SPEED	VOLT.	FREQ	INSUL.	TIME RATING	MODEL	FRAME NO.
		RPM.	V.	HZ	F	CONT.	TIK-FCKTW	N315LL

Preliminary Drawing for Reference Only

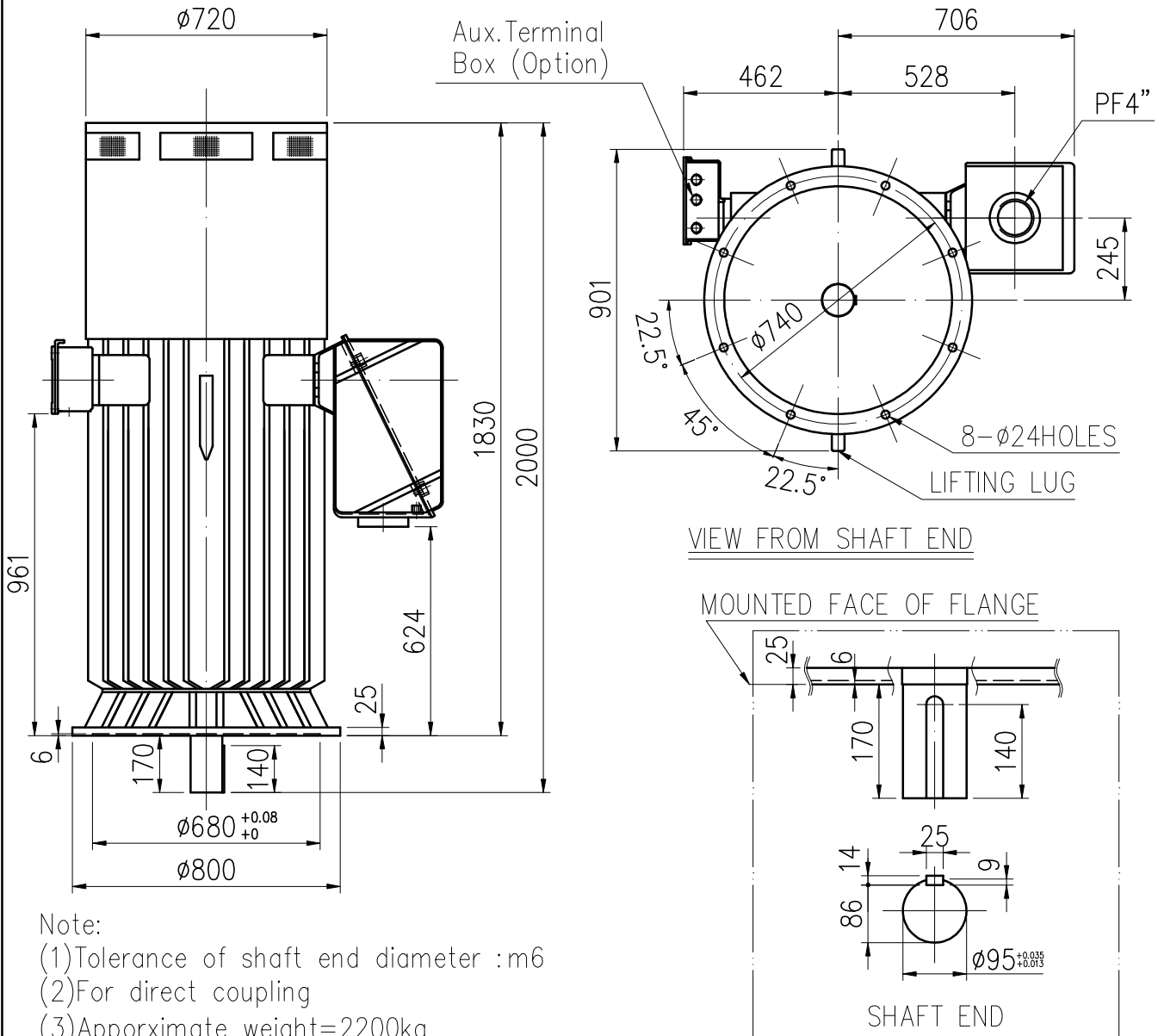

Note:

- (1) Tolerance of shaft end diameter : m6
- (2) For direct coupling
- (3) Approximate weight=2200kg
- (4) Auxiliary terminal box is optional and dependent on specified accessories
- (5) Drive end bearing: 6320C3(lubrication: grease)
opposite drive end bearing: 7320B(lubrication: grease)
- (6) Extra down thrust load shall not be allowed
- (7) Without nonreverse ratchet mechanism



BASIC DWG NO: AL-FB-4396

CERTIFIED	BY:	DATE:
DESIGNED	Y.R.YANG	DIMENSIONS IN mm
CHECKED	T.F.CHENG	3RD ANGLE PROJECTION
APPROVED	T.F.CHENG	DATE: MAR.10.2010