

# OUTLINE 3-PHASE INDUCTION MOTOR

TOTALLY ENCLOSED FAN  
COOLED, SQUIRREL CAGE  
ROTOR  
PREMIUM EFFICIENCY  
IE3 SERIES

FILE NO:

CUSTOMER:

PO. NO:

ORDER NO:

OUTPUT	POLE	SYN. SPEED	VOLT.	FREQ.	TIME RATING	MODEL	FRAME NO.
					S1	FHFC	160L

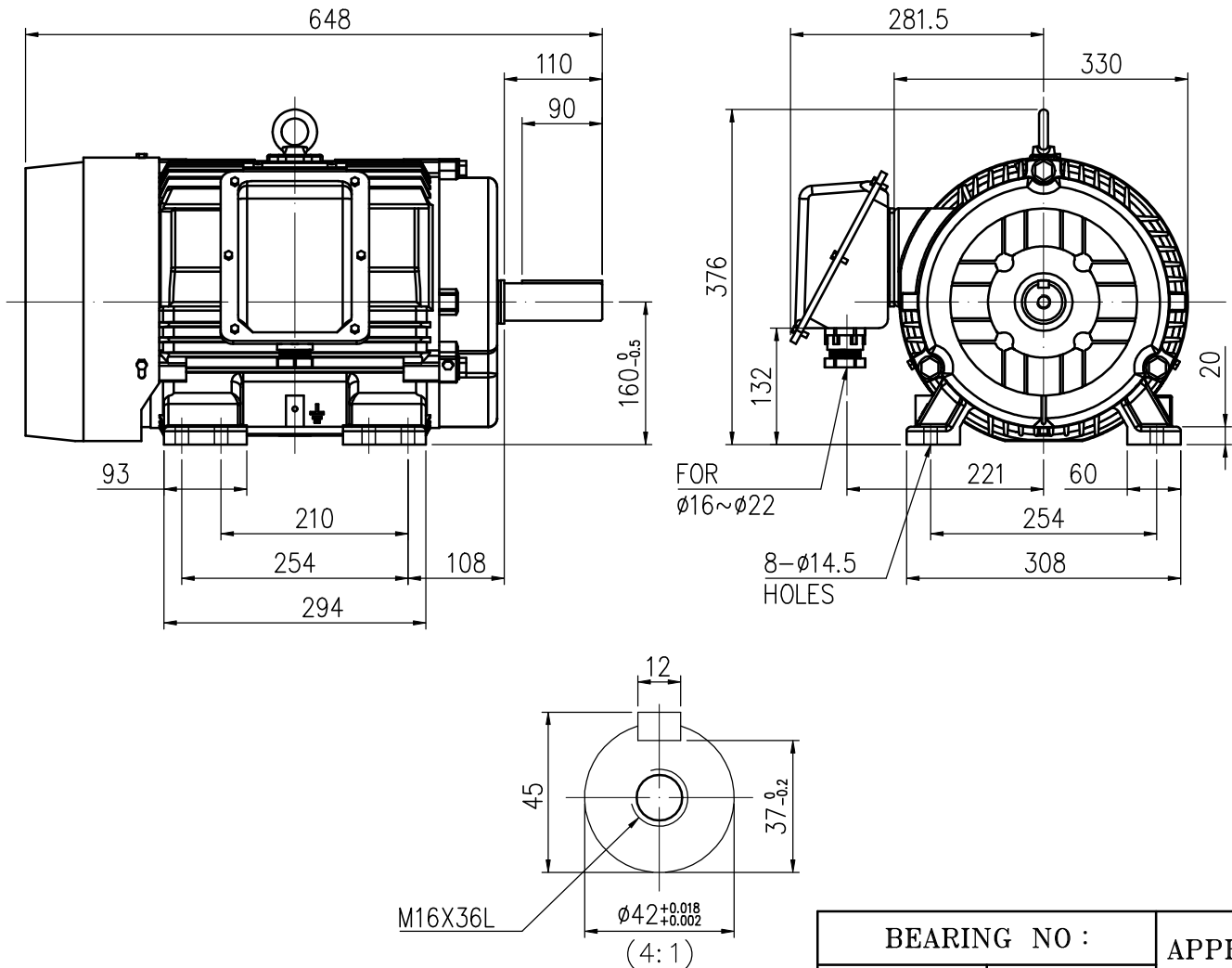

NOTE: 1. F CLASS INSULATION.  
2. IP55.

BEARING NO :		APPROX. WEIGHT
D.E	O.D.E	
6310ZZC3	6208ZZC3	130kg

Preliminary Drawing for Reference Only



CERTIFIED BY : _____		DATE : _____	
DESIGNED	J.Y. SU	DWG. NO : AS-104762	REV.
CHECKED	C.P. SU	3RD ANGLE PROJECTION	00
APPROVED	C.P. SU	DIMENSIONS IN mm	