

OUTLINE 3-PHASE INDUCTION MOTOR

TOTALLY ENCLOSED FAN
COOLED, SQUIRREL CAGE
ROTOR
PREMIUM EFFICIENCY
IE3 SERIES

FILE NO:
CUSTOMER:
PO. NO:
ORDER NO:

OUTPUT	POLE	SYN. SPEED	VOLT.	FREQ	TIME RATING	MODEL	FRAME NO.
					S1	FHFC-W	280S

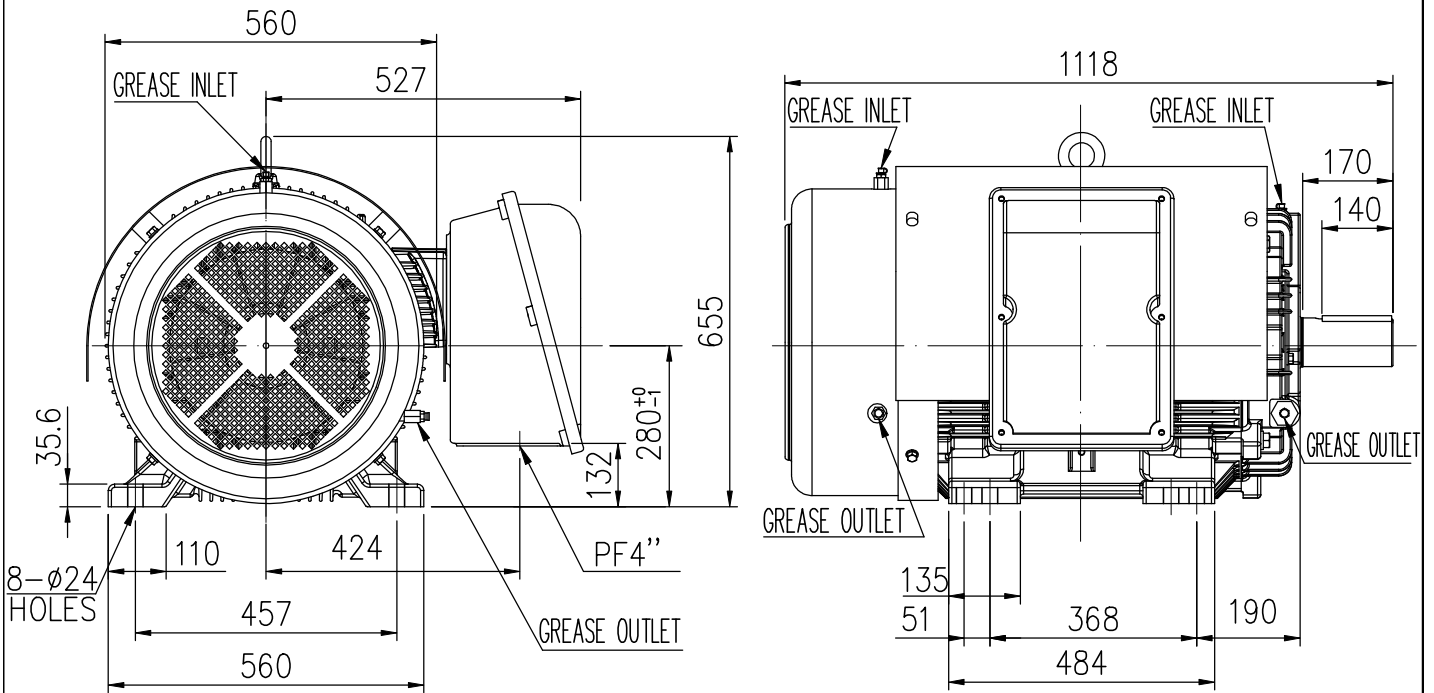

NOTE: 1. F CLASS INSULATION.
2. FOR DIRECT COUPLING.

BEARING NO.		APPROX WEIGHT
D.E	O.D.E	
6318ZC3	6316ZC3	670 kg

Preliminary Drawing for Reference Only



CERTIFIED	BY: _____	DATE: _____	
DESIGNED	W.T. LIAO	DWG. NO: AS-032559	REV.
CHECKED	S.Y. HSIAO	3RD ANGLE PROJECTION	(00)
APPROVED	S.Y. HSIAO	DIMENSION IN mm	