

OUTLINE 3-PHASE INDUCTION MOTOR

TOTALLY ENCLOSED FAN
COOLED, SQUIRREL CAGE
ROTOR
PREMIUM EFFICIENCY
IE3 SERIES

FILE NO:
CUSTOMER:
PO. NO:
ORDER NO:

OUTPUT	POLE	SYN. SPEED	VOLT.	FREQ.	TIME RATING	MODEL	FRAME NO.
					S1	FHFC-DW	90L

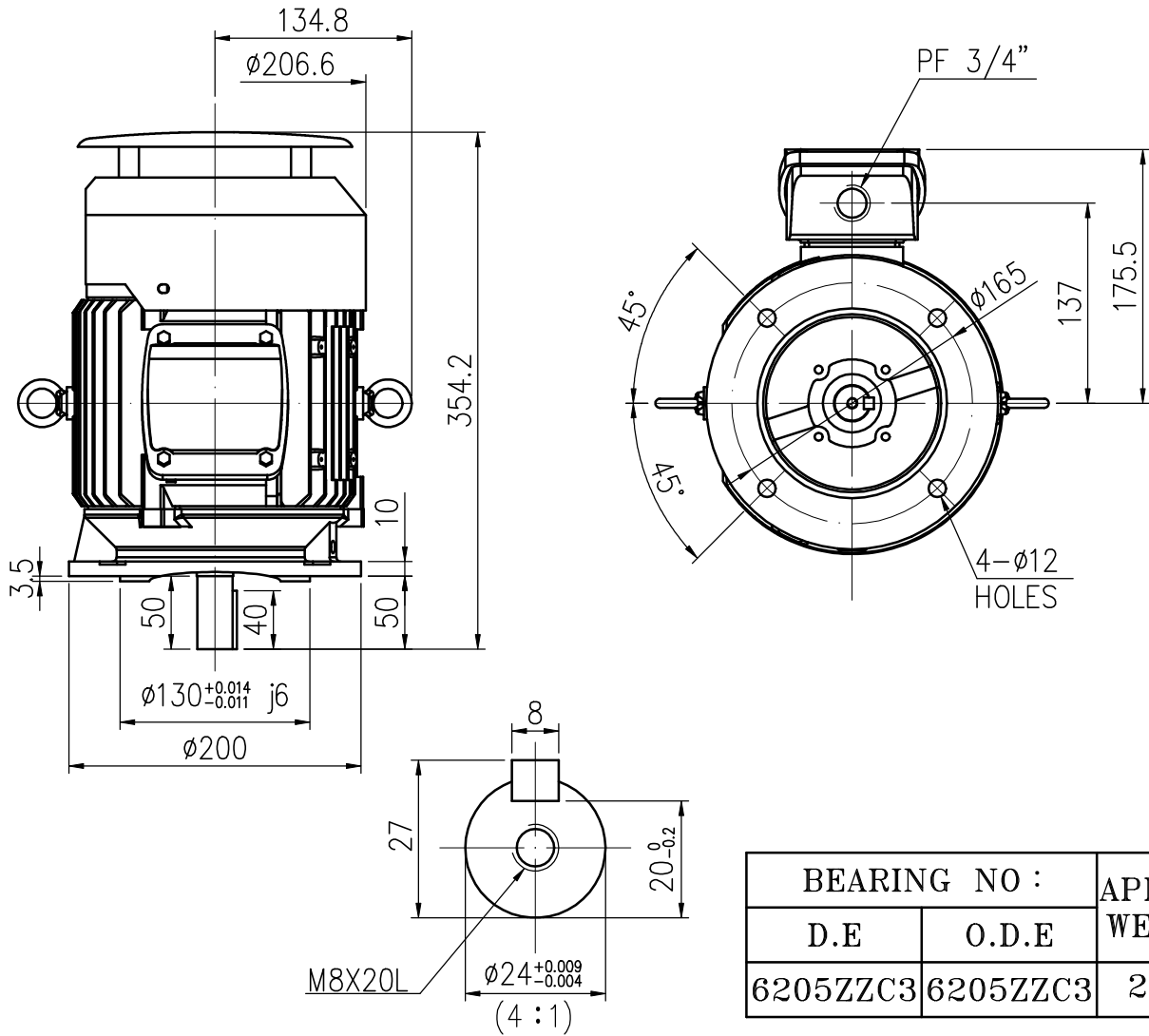

BEARING NO :		APPROX. WEIGHT
D.E	O.D.E	
6205ZZC3	6205ZZC3	26kg

- NOTE: 1. F CLASS INSULATION.
2. IP55.
3. WITH CAST IRON T-BOX.

Preliminary Drawing for Reference Only



CERTIFIED BY : _____		DATE : _____	
DESIGNED	J.Y. SU	DWG. NO : AS-104288	REV.
CHECKED	C.P. SU	3RD ANGLE PROJECTION	00
APPROVED	C.P. SU	DIMENSIONS IN mm	