

OUTLINE 3-PHASE INDUCTION MOTOR

TOTALLY ENCLOSED FAN
COOLED, SQUIRREL CAGE
ROTOR

FILE NO:

CUSTOMER:

PO. NO:

ORDER NO:

OUTPUT	POLE	SYN. SPEED	VOLT.	FREQ	TIME RATING	MODEL	FRAME NO.
					CONT.	TEFC-DXX	324TC

- * CLASS I , DIVISION I , GROUP D
- * CLASS II , DIVISION I , GROUP E, F & G

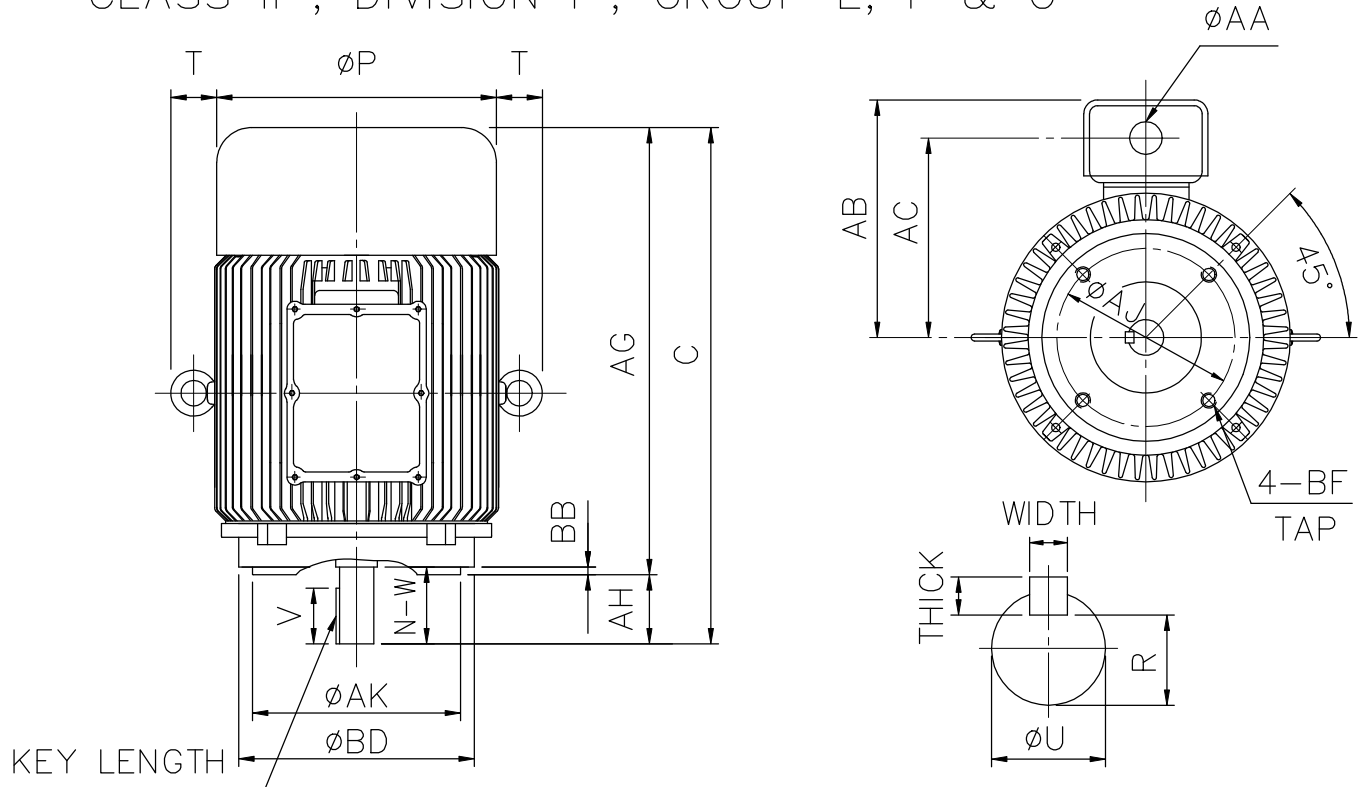

FLANGE					C	AG	AH	P+2T	AC			
AJ	AK	BB	BD	BF								
11.000	12.50	0.25	14.00	5/8-11"	31.42	26.42	5.00	22.84	13.38			

SHAFT EXTENSION			KEY			KEYSEAT R	TERMINAL BOX		APPROX WEIGHT
N-W	U	V	WIDTH	THICK	LENGTH		AA	AB	
5.25	2.125	5.00	0.500	0.500	3.91	1.845	NPT2"	18.31	790 lb

- NOTE: 1. TOLERANCE ON DIMENSION AK: +0.000.-0.003 inch
 2. TOLERANCE ON DIMENSION U: +0.000.-0.001 inch
 3. TOLERANCE OF DIMENSION R: +0.000.-0.015 inch
 4. F CLASS INSULATION.

BEARING NO.	
D.E.	O.D.E.
6312	6312

Preliminary Drawing for Reference Only



CERTIFIED BY : _____		DATE : _____	
DESIGNED	W. D. KUO	DWG. NO: AS-003101	
CHECKED	L. J. LEE	3RD ANGLE PROJECTION	
APPROVED	T. M. LIAO	DIMENSION IN inch	