

EXPLOSION-PROOF MOTORS

SQUIRREL-CAGE INDUCTION

ENCLOSURE: TOTALLY ENCLOSED
HORIZONTAL: FOOT-MOUNTED

CAST IRON FRAME
FRAME 324TS

COOLING: FAN COOLED
CLASS I , DIVISION I , GROUP D.

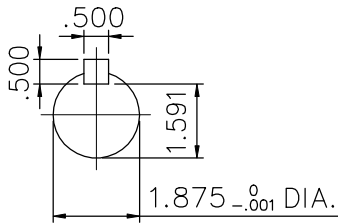
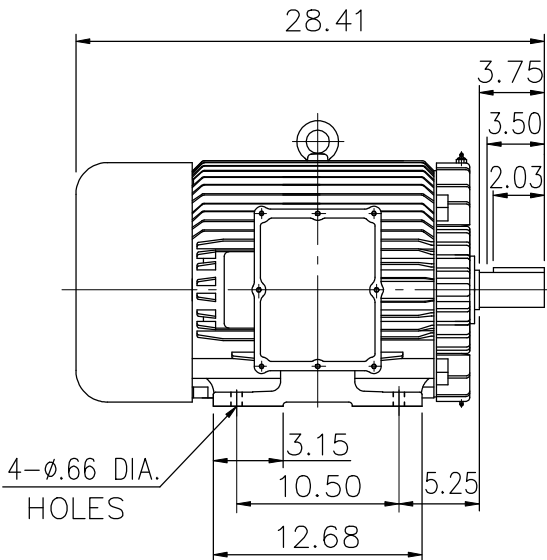
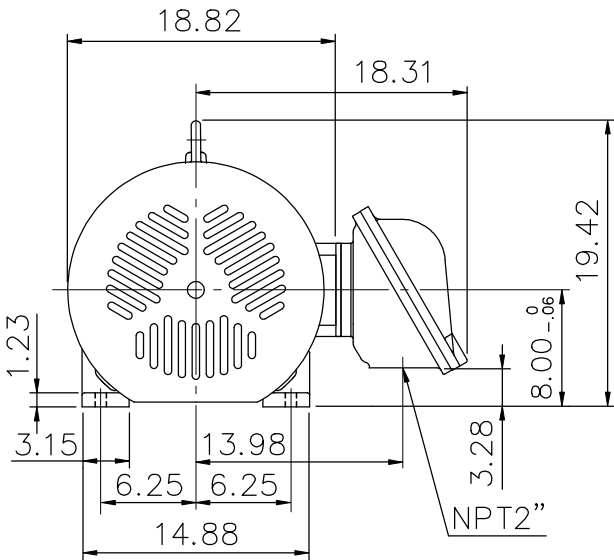

- (1) DIMENSIONS ARE IN INCHES.
- (2) APPROXIMATE WEIGHT= 804 LBS
- (3) INTERNAL VOLUME OF CONDUIT BOX= 359.4 CU, IN.
- (4) DRIVE END BEARING 6312C3
OPPOSITE DRIVE END BEARING 6312C3
- (5) ALL DATA SUBJECT TO CHANGE WITHOUT NOTICE
- (6) FOR CONSTRUCTION USE ONLY CERTIFIED DATA

Preliminary Drawing for Reference Only

OUTPUT	POLE	SYN. SPEED	VOLT	FREQ.	CERTIFIED BY _____ DATE _____	
					DR. BY <u>W. D. KUD</u> CK. BY <u>L. J. LEE</u> APP. BY <u>T. M. LIAD</u> DATE <u>NOV. 27, 2008</u>	
					DIMENSION SHEET	