

# EXPLOSION-PROOF MOTORS

SQUIRREL-CAGE INDUCTION

ENCLOSURE: TOTALLY ENCLOSED  
HORIZONTAL: FOOT-MOUNTED

CAST IRON FRAME  
FRAME 324TS

COOLING: FAN COOLED  
CLASS I , DIVISION I , GROUP D.  
CLASS II , DIVISION I , GROUP E,F & G

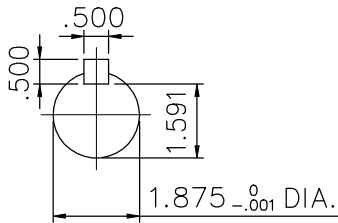
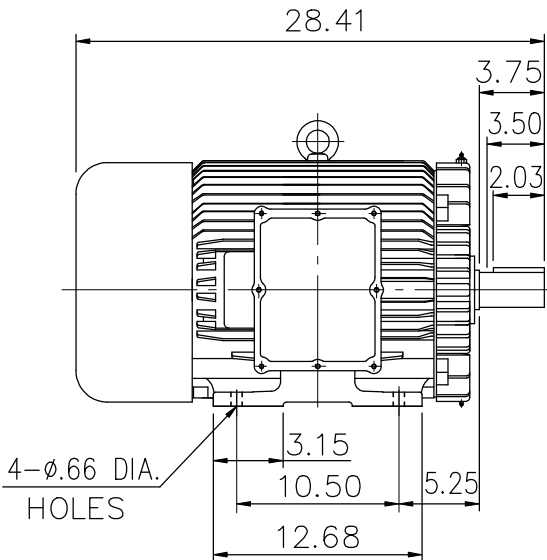
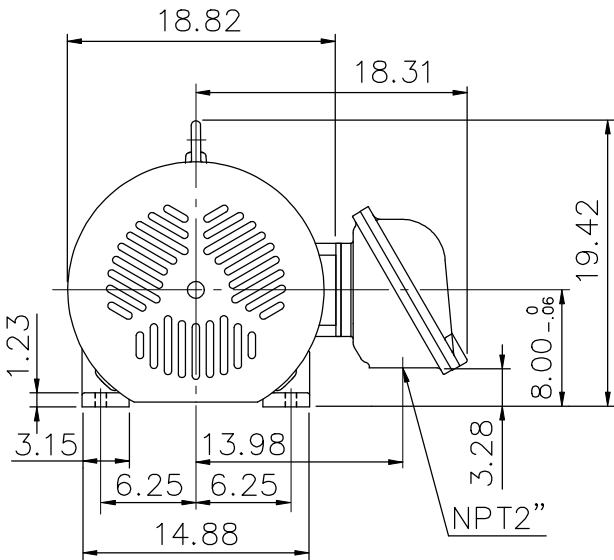

- (1) DIMENSIONS ARE IN INCHES.
- (2) APPROXIMATE WEIGHT= 804 LBS
- (3) INTERNAL VOLUME OF CONDUIT BOX= 359.4 CU, IN.
- (4) DRIVE END BEARING 6312C3  
OPPOSITE DRIVE END BEARING 6312C3
- (5) ALL DATA SUBJECT TO CHANGE WITHOUT NOTICE
- (6) FOR CONSTRUCTION USE ONLY CERTIFIED DATA

Preliminary Drawing for Reference Only

OUTPUT	POLE	SYN. SPEED	VOLT	FREQ.	CERTIFIED BY _____ DATE _____	
					DR. BY	W. D. KUD
					CK. BY	L. J. LEE
					APP. BY	T. M. LIAD
					DATE	NOV. 27, 2008
					DIMENSION SHEET	AS-968618