

SUPER-MAX ALTERNATING CURRENT MOTORS

SQUIRREL-CAGE INDUCTION

CAST-IRON FRAME

ENCLOSURE: OPEN DRIP PROOF
 MOUNTING: FOOT
 COOLING: SELF-VENTILATION

FRAME 326TC

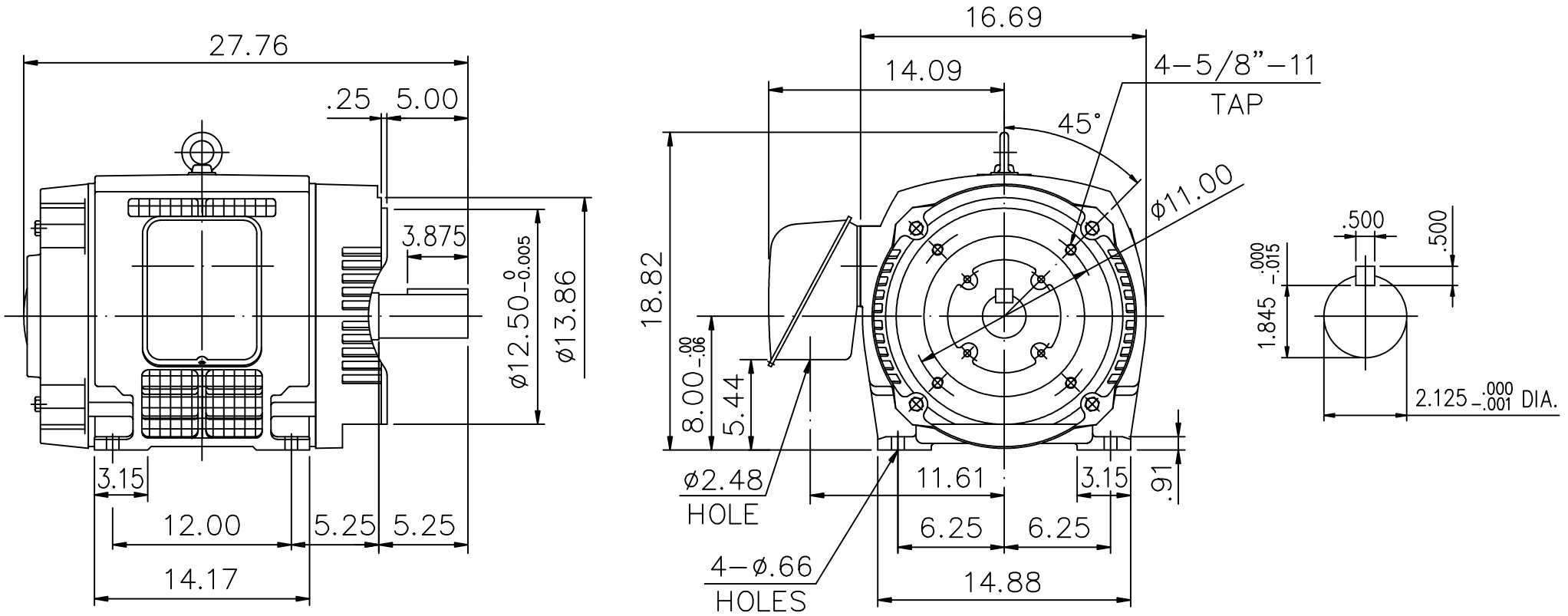

- (1) DIMENSIONS ARE IN INCHES.
- (2) APPROXIMATE WEIGHT = 50 HP, 4 P, - 639 LBS.
 30 HP, 6 P, - 639 LBS.
- (3) DRIVE END BEARING 6312
 OPPOSITE DRIVE END BEARING 6312
- (4) INTERNAL VOLUME OF CONDUIT BOX=244 CU, IN.

OUTPUT	POLE	SYN. SPEED	VOLT	FREQ.	CERTIFIED BY _____ DATE _____
					DR. BY <u>W. D. KUD</u> CK. BY <u>L. J. LEE</u> APP. BY <u>T. M. LIAD</u> DATE <u>JUN. 18. 2010</u>
DIMENSION SHEET					AS-992196