

SUPER-MAX ALTERNATING CURRENT MOTORS

SQUIRREL-CAGE INDUCTION

CAST-IRON FRAME

ENCLOSURE: OPEN DRIP PROOF
 MOUNTING: FOOT
 COOLING: SELF-VENTILATION

FRAME 444TSC

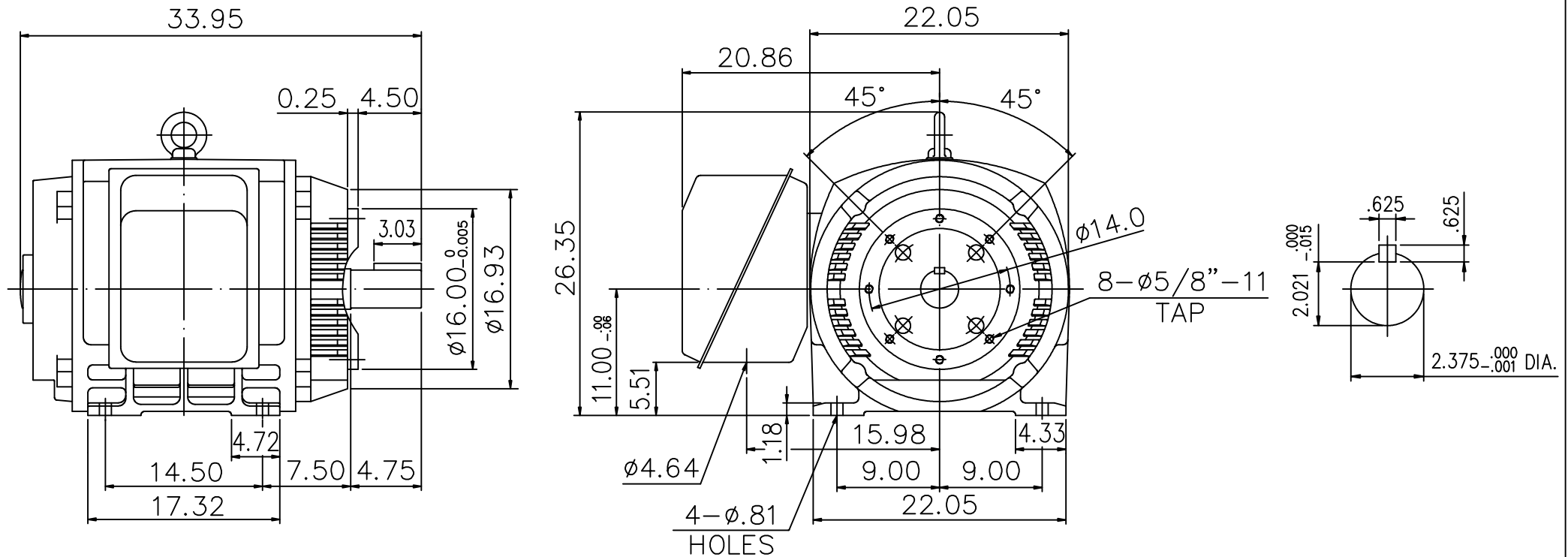

- (1) DIMENSIONS ARE IN INCHES.
- (2) APPROXIMATE WEIGHT =200HP, 2P, -1494LBS.
- (3) DRIVE END BEARING 6313C3
 OPPOSITE DRIVE END BEARING 6313C3
- (4) INTERNAL VOLUME OF CONDUIT BOX=1185 CU, IN.

OUTPUT	POLE	SYN. SPEED	VOLT	FREQ.	CERTIFIED BY _____ DATE _____
					DIMENSION SHEET
DR. BY <u>W. D. KUO</u> CK. BY <u>L. J. LEE</u> APP. BY <u>T. M. LIAD</u> DATE <u>JUN. 18. 2010</u>					