

SUPERMAX-841 SEVERE DUTY ALTERNATING CURRENT MOTORS

SQUIRREL-CAGE INDUCTION

ENCLOSURE: TOTALLY ENCLOSED

MOUNTING: FOOT

CAST IRON FRAME

FRAME 449TS

COOLING: FAN COOLED

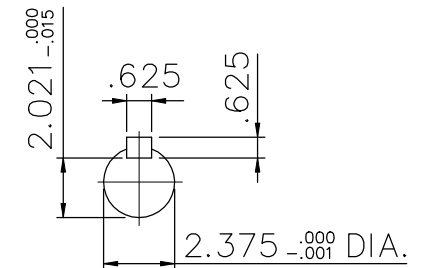
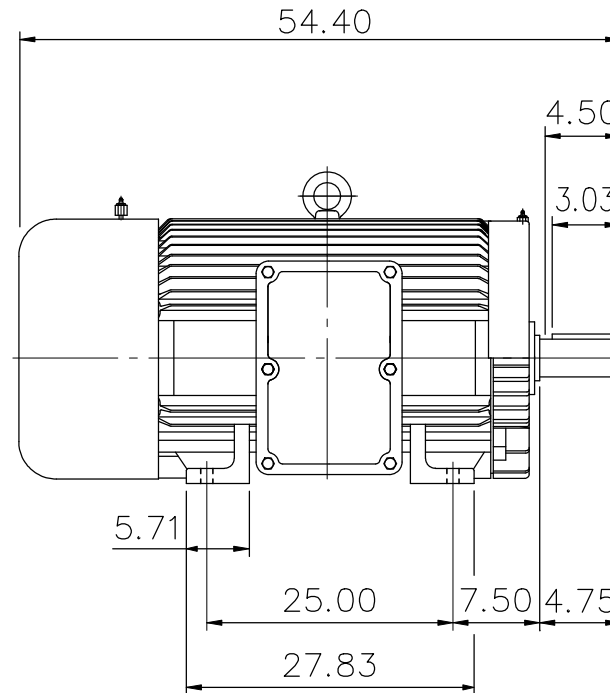
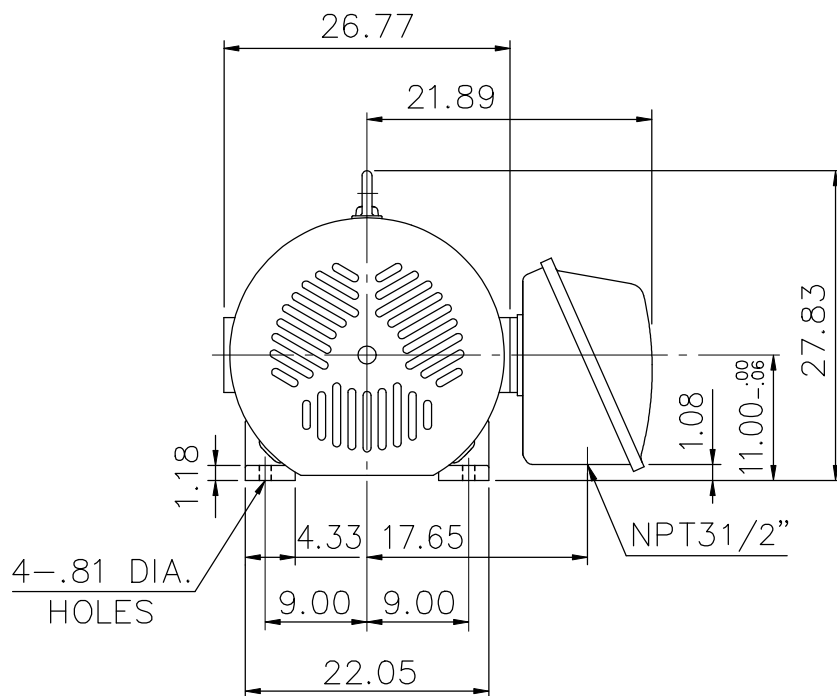

- (1) DIMENSIONS ARE IN INCHES.
- (2) APPROXIMATE WEIGHT = 2900 LBS
- (3) DRIVE END BEARING 6313C3
OPPOSITE DRIVE END BEARING 6313C3
- (4) INTERNAL VOLUME OF CONDUIT BOX= 1011 CU, IN.

Preliminary Drawing for Reference Only

OUTPUT	POLE	SYN. SPEED	VOLT	FREQ.	CERTIFIED BY _____ DATE _____	
					DR. BY	W. D. KUD
					CK. BY	L. J. LEE
					APP. BY	T. M. LIAD
					DATE	NOV. 27, 2008
DIMENSION SHEET					AS-873103	