

SUPERMAX-841 SEVERE DUTY ALTERNATING CURRENT MOTORS

SQUIRREL-CAGE INDUCTION

ENCLOSURE: TOTALLY ENCLOSED
MOUNTING: FOOT

CAST IRON FRAME
FRAME 365T

COOLING: FAN COOLED

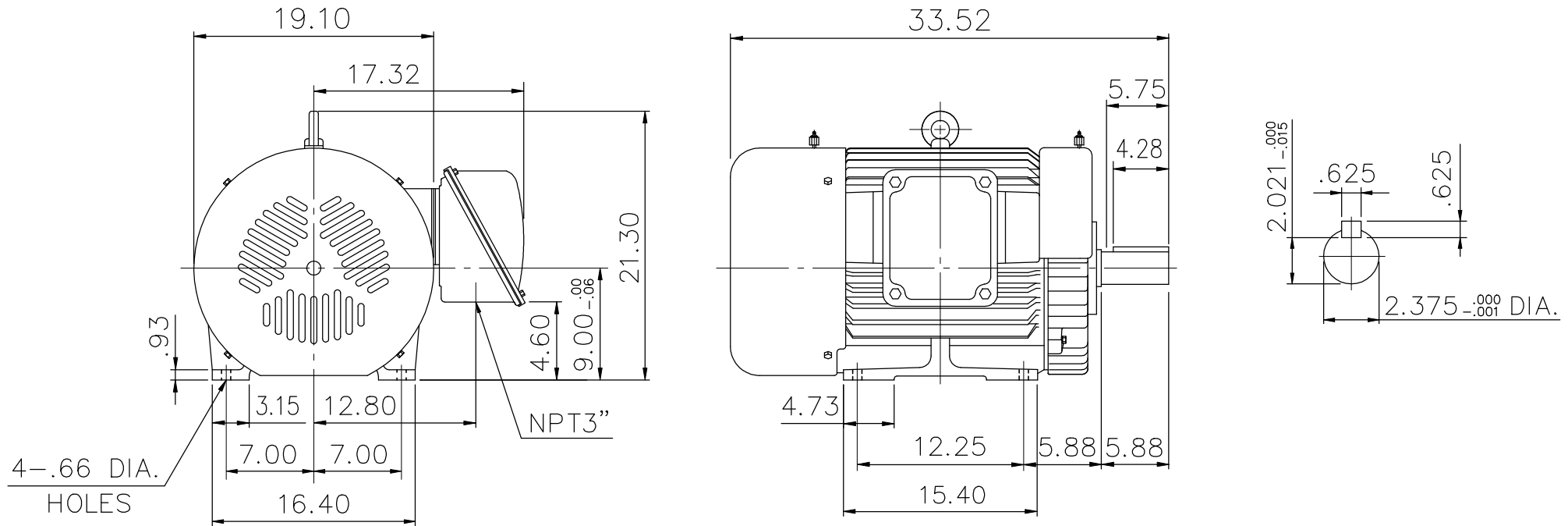

- < 1) DIMENSIONS ARE IN INCHES.
- < 2) APPROXIMATE WEIGHT= 981 LBS
- < 3) DRIVE END BEARING 6315C3
OPPOSITE DRIVE END BEARING 6312C3
- < 4) INTERNAL VOLUME OF CONDUIT BOX= 551 CU, IN.

Preliminary Drawing for Reference Only

OUTPUT	POLE	SYN. SPEED	VOLT	FREQ.	CERTIFIED BY _____ DATE _____	
					DR. BY <u>W. D. KUD</u> CK. BY <u>L. J. LEE</u> APP. BY <u>T. M. LIAD</u> DATE <u>NOV. 27, 2008</u>	
					DIMENSION SHEET	