

**OUTLINE
3-PHASE
INDUCTION GENERATOR**

WEATHER PROTECTED
TYPE I
SQUIRREL CAGE ROTOR
ANTI-FRICTION BEARING

PROJECT NO:

CUSTOMER:

PO. NO:

ORDER NO:

OUTPUT	POLE	SYN. SPEED RPM.	VOLT. V.	FREQ HZ	INSUL. F	TIME RATING CONT.	MODEL TIK-VCK	FRAME NO. 6310
--------	------	--------------------	-------------	------------	-------------	----------------------	------------------	-------------------

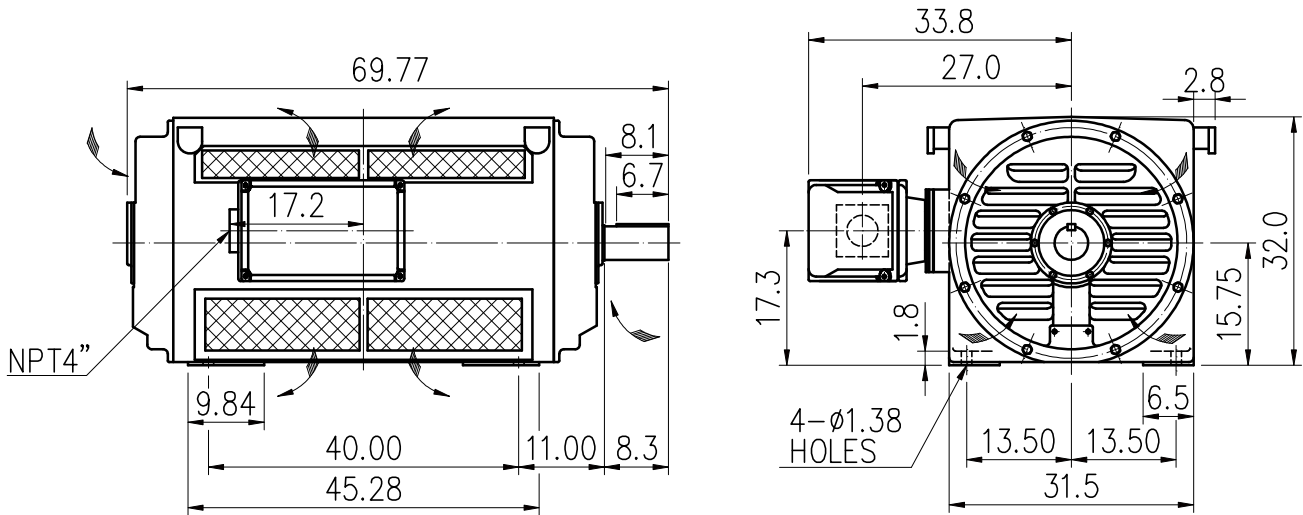

DETAIL OF SHAFT END
2:1

- 1) Tolerance of shaft end diameter : +0.00 inch ~ -0.06 inch.
- 2) Tolerance of shaft center height : +0.00 inch ~ -0.001 inch.
- 3) For direct coupling.
- 4) Approximate weight = 7500 LBS
- 5) Drive end bearing: 6224C3
Opposite drive end bearing: 6224C3

Preliminary Drawing for Reference Only



BASIC DWG NO: AL-VB-1755

CERTIFIED BY:		DATE:
DESIGNED	C.Y.WEN	DIMENSIONS IN INCH
CHECKED	T.F.CHENG	3RD ANGLE PROJECTION
APPROVED	T.F.CHENG	DATE: JAN.25.2010