

OUTLINE 3-PHASE INDUCTION GENERATOR

WEATHER PROTECTED
TYPE I
SQUIRREL CAGE ROTOR
ANTI-FRICTION BEARING

PROJECT NO:

CUSTOMER:

PO. NO:

ORDER NO:

OUTPUT	POLE	SYN. SPEED	VOLT.	FREQ	INSUL.	TIME RATING	MODEL	FRAME NO.
		RPM.	V.	HZ	F	CONT.	TIK-VCK	6810

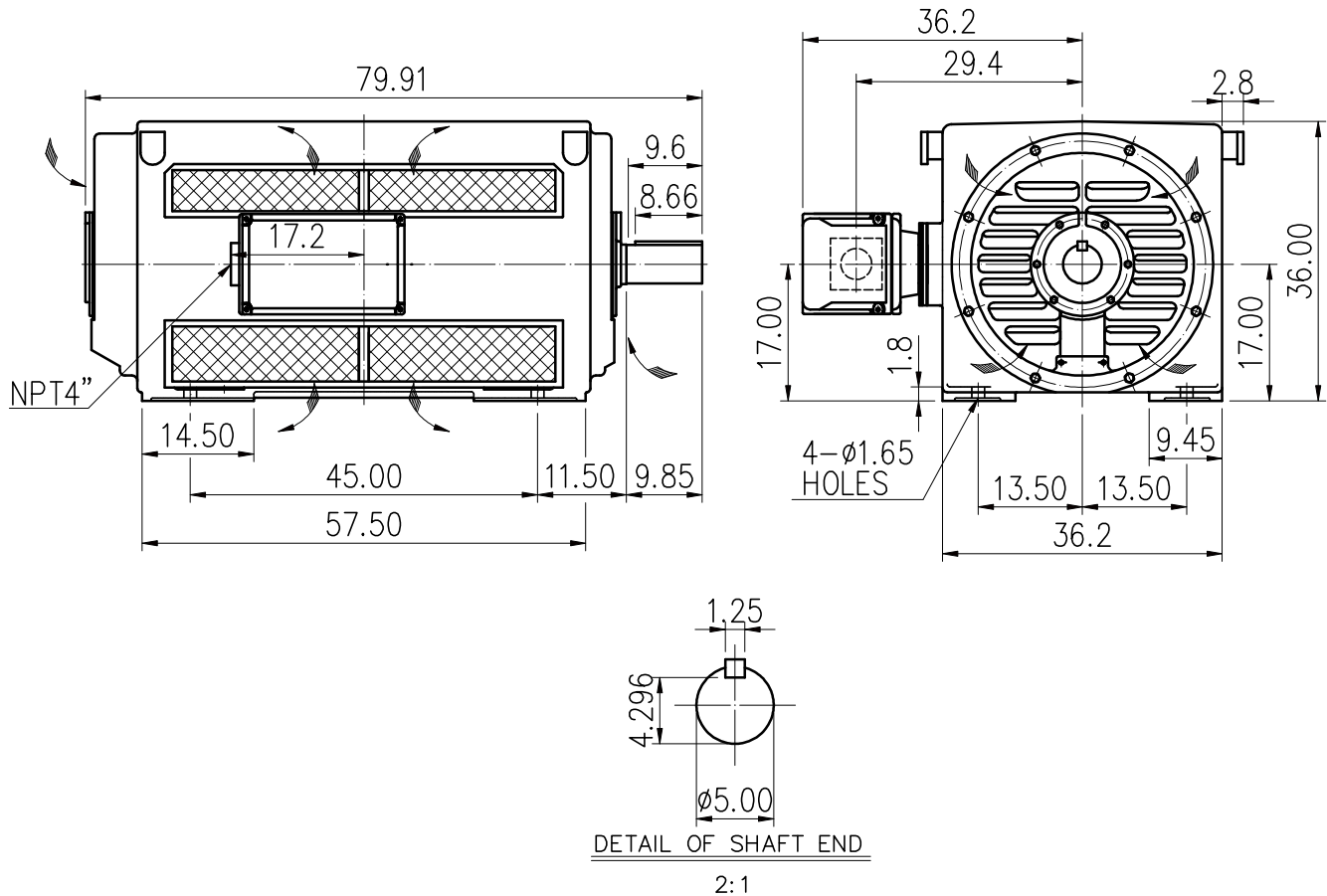

- 1) Tolerance of shaft end diameter : +0.00 inch ~ -0.06 inch.
- 2) Tolerance of shaft center height : +0.00 inch ~ -0.001 inch.
- 3) For direct coupling.
- 4) Approximate weight = 8580 LBS
- 5) Drive end bearing: 6318C3
Opposite drive end bearing: 6318C3

Preliminary Drawing for Reference Only



BASIC DWG NO: AL-VB-1759

CERTIFIED BY:		DATE:
DESIGNED	C.Y.WEN	DIMENSIONS IN INCH
CHECKED	T.F.CHENG	3RD ANGLE PROJECTION
APPROVED	T.F.CHENG	DATE: JAN.25.2010