

OUTLINE 3-PHASE INDUCTION MOTOR

TOTALLY ENCLOSED FAN
COOLED, SQUIRREL CAGE
ROTOR

FILE NO:
CUSTOMER:
PO. NO:
ORDER NO:

OUTPUT	POLE	SYN. SPEED	VOLT.	FREQ.	TIME RATING	MODEL	FRAME NO.
					CONT.	TEFC-DXX	143TC

- * Class I , Division I , Group D
- * Class II , Division I , Group E, F & G

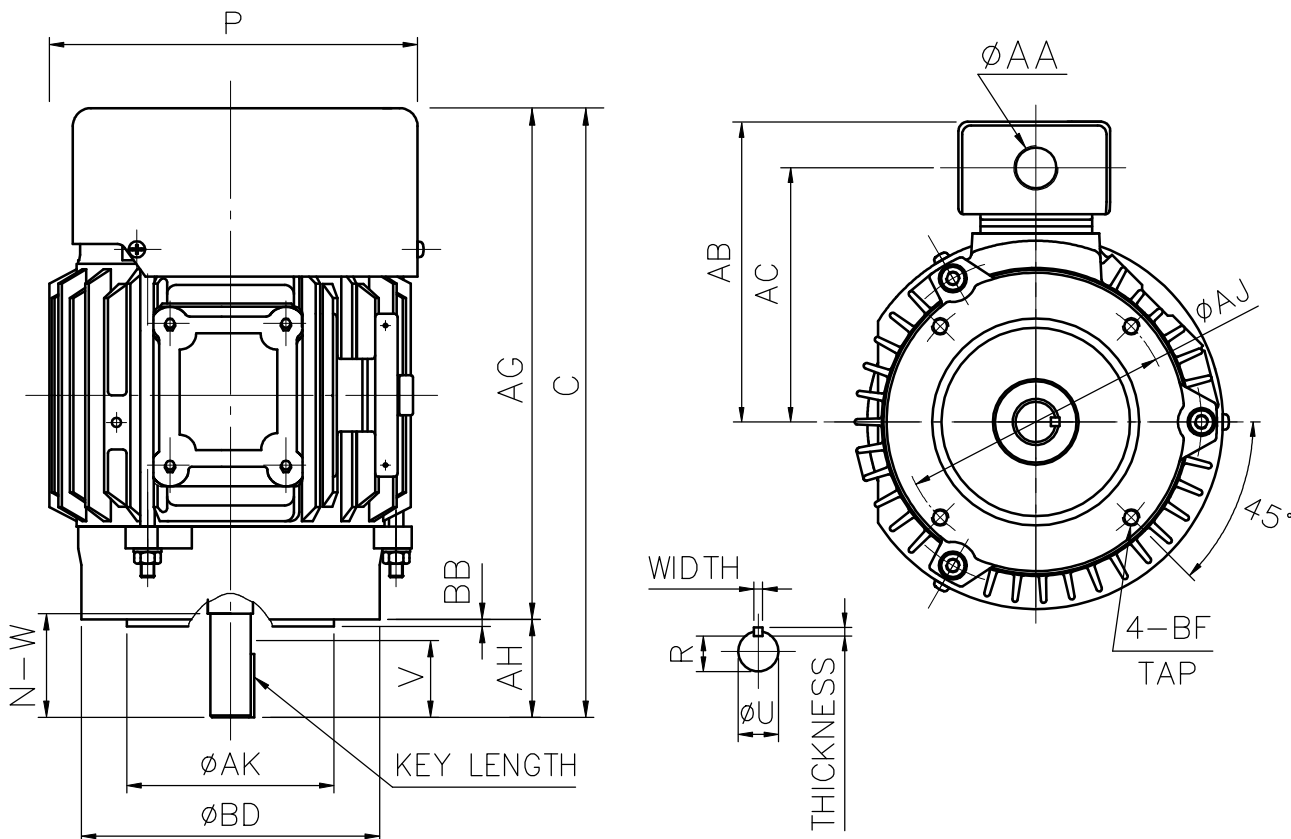

P	C	AG	BF	BB	BD	AK	AH	AJ	AC	SHAFT EXTENSION		
										N-W	U	V
8.40	14.43	12.31	3/8-16	0.16	6.50	4.50	2.12	5.875	7.00	2.25	0.875	2.20

CONDUIT BOX		KEY			KEY SEAT	BEARING NO.		APPROX WT.
AA	AB	WIDTH	THICKNESS	LENGTH	R	D.E.	O.D.E.	
NPT3/4"	8.80	0.188	0.188	1.375	0.771	6205ZZ	6205ZZ	86 lb

- NOTE: 1. TOLERANCE ON DIMENSION U: +0.000 inch, -0.0005 inch.
 2. TOLERANCE ON DIMENSION AK: +0.000 inch, -0.003 inch.
 3. DIMENSION V IS LENGTH OF STRAIGHT PART SHAFT.
 4. F CLASS INSULATION

初步圖面，僅供參考

CERTIFIED BY : _____ DATE : _____



DESIGNED	W. D. KUO	DWG. NO: AS-975023
CHECKED	L. J. LEE	3RD ANGLE PROJECTION
APPROVED	T. M. LIAO	DIMENSIONS IN inch